

INDIE

The Way to Be

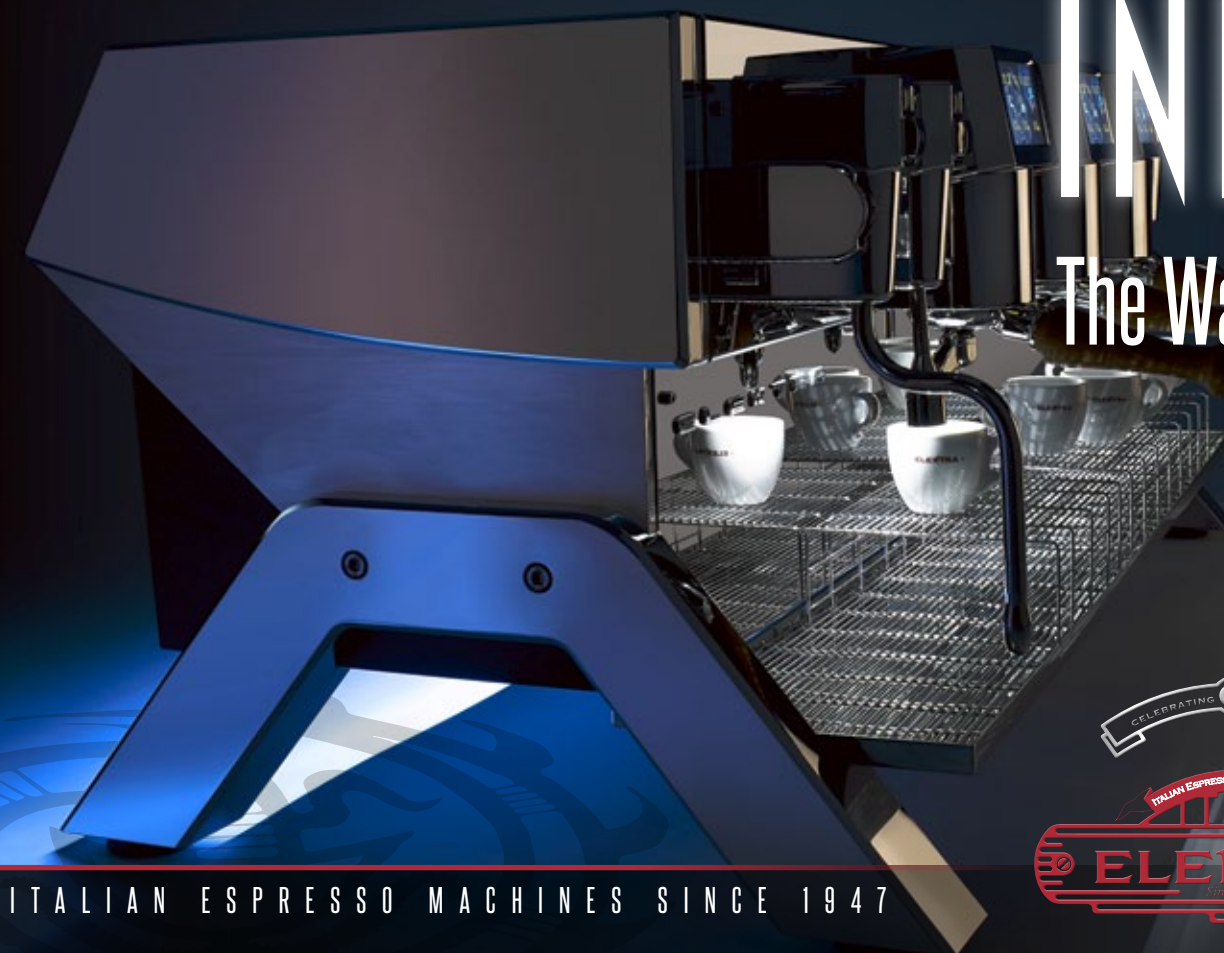

ITALIAN ESPRESSO MACHINES SINCE 1947



WHY INDIE PERCHÉ INDIE

INDIE is an innovative, original, independent choice; as the musical movement from which it draws its name, INDIE is also a true lifestyle, made of passion for beautiful and well-made, authentic things. The lifestyle for baristas out of the ordinary.

INDIE è una scelta innovativa, originale, indipendente; come il movimento musicale da cui trae il nome, INDIE è anche un vero e proprio stile di vita, fatto di passione per le cose belle e ben fatte, autentiche.
Lo stile dei baristi fuori dal comune.



02 THE WAY TO BE SPECIALTY ESSERE SPECIALTY

INDIE likes open minds, the experimenters, innovators and the fans of the best coffee. INDIE is the result of a brave thought, unconventional.

INDIE is a project that can give great satisfaction to baristas. His world are the professionals of Specialty Coffee, coffee lovers and any trendy local.

INDIE piace alle menti aperte, agli sperimentatori, agli innovatori e a tutti gli appassionati del miglior caffè. È il frutto di un pensiero coraggioso, fuori dagli schemi.

È un progetto che sa dare completa soddisfazione ai baristi.

Il suo mondo è quello dello Specialty Coffee, dei cultori del caffè e dei locali evoluti.



INDIE

04 THE WAY TO BE INDEPENDENT ESSERE INDIPENDENTI

INDIE



The content of technology, the ergonomic part and the usability study allow to the more demanding baristas to express themselves to the best of their ability.

Their personal interpretation of preparing the Espresso will be then independent by all that, until now, has not been a free choice.

La dotazione di tecnologia, gli studi di usability e la componente ergonomica permettono ai più esigenti e preparati baristi di esprimersi al meglio.

La loro personale interpretazione del caffè espresso sarà così indipendente da tutto quello che fino ad oggi non è stata una libera scelta.





The exclusive solid oak wood handle has been designed just for INDIE.

L'esclusiva impugnatura in legno di rovere massiccio è stata disegnata appositamente per INDIE.

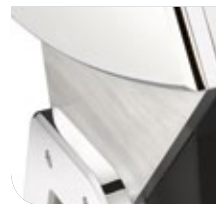

06 THE WAY TO BE ADVANCED

ANTICIPARE I TEMPI

INDIE



INDIE is result of research of an unconventional design who has redesigned the geometry, the prospects and the materials. Steel, aluminum, oak, exclusive icons and light design are its themes.

INDIE has two different kinds of lighting, one with a fixed light on the worktop and one more in the rear with LED lights with variable and programmable colors (BLS).

INDIE è frutto di una ricerca di design anticonformista che ha ripensato le geometrie, le prospettive e i materiali. Acciaio, alluminio, legno di rovere, icone e light design.

INDIE possiede due diverse tipologie di illuminazione, una del piano di lavoro a luce fissa ed una della carrozzeria posteriore a luce programmabile.

BLAVIC



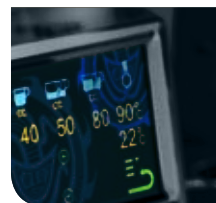

Each intelligent display controls the thermoregulation of each group, the adjusting of the coffee dose and the infusion time, all in real time.

Ogni display intelligente controlla la termoregolazione di un singolo gruppo, la regolazione della dose di caffè e la durata di infusione, tutto in tempo reale.

08

THE WAY TO BE INNOVATIVE

ESSERE INNOVATIVI

INDIE



INDIE manages each group independently. All the functions are accessible by a color touch screen display.

INDIE Manage the brewing temperature control on each group independently, with accuracy and rapidity never achieved before thanks to a very reduced thermal inertia.

INDIE gestisce ogni gruppo in modo indipendente. Tutte le sue funzioni sono accessibili da un display touchscreen a colori.

INDIE consente la regolazione della temperatura reale di infusione in modo indipendente su ogni gruppo, con una precisione e una rapidità di risposta mai raggiunta prima, grazie ad una ridottissima inerzia termica

View more with QR code

BARISTA DISPLAY INFO

TOUCH SCREEN USER INTERFACE





By means of a handy and patented wheel regulator it's possible to customize the steam pressure.

Attraverso una pratico erogatore è possibile regolare il flusso del vapore.



10 THE WAY TO BE SMART

ESSERE INTELLIGENTI

INDIE



INDIE comes equipped with patented steam wand with which it is possible to make a pressure fine adjustment from 0.8 to 1.8 BAR, with the capability to heat up 30 Liters/Hour. INDIE has the possibility to adjust the volume of the hot water through a simple programming. It also keeps the cups at the right service temperature, thanks to a cup holder warmed by an innovative heating system.

INDIE presenta un erogatore vapore brevettato nel quale è possibile regolare il flusso con una pressione variabile da 0,8 a 1,8 atmosfere, permettendo di riscaldare fino a 30 lt/h. INDIE ha la possibilità di regolare il volume dell'acqua calda attraverso una semplice programmazione. Mantiene inoltre le tazze sempre alla giusta temperatura di servizio, grazie ad un portatazze riscaldato da un innovativo sistema di riscaldamento.

View more with QR code

STEAM WAND

EROGATORE VAPORE





With the advanced steam wand nozzle, we get the right creaminess on the frothed milk.

L'evolutivo spruzzatore del montalatte, conferisce al latte montato la giusta cremosità.



The properties of the frothed milk, can be set on the touch- screen display.

Sul touch-screen è possibile impostare i parametri d'uso del montalatte.

12 THE WAY TO BE CREATIVE ESSERE CREATIVI

INDIE



On request, INDIE can be equipped with automatic and **PATENTED Milk Frothing System** (optional), programmable milk temperature from 50 to 70 C°, regulation of the milk foam volume and self-diagnosis of cleaning. The touch-screen display shows the functions of the milk frother, the parameters can easily be changed by the barista to have the perfect creaminess for cappuccinos.

Su richiesta, INDIE può essere dotata di un evoluto **Montalatte Automatico BREVETTATO** (optional), con programmazione della temperatura da 50 a 70 C°, regolazione della quantità di schiuma e autodiagnosi per la pulizia. Sul display touch-screen vengono mostrati i parametri di funzionamento del montalatte, che possono facilmente essere variati dal barista, fino a raggiungere la cremosità ideale per la preparazione di spettacolari cappuccini.

View more with QR code MILK FROTHING SYSTEM

MONTALATTE AUTOMATICO





14 

IND2B

INDIE

2 GROUPS AUTOMATIC, STEEL/ALUMINUM "STEALTH BLACK"
2 GRUPPI AUTOMATICA, ACCIAIO/ALLUMINIO "STEALTH BLACK"

THE WAY TO BE





BLACK





16 

IND2W

INDIE

2 GROUPS AUTOMATIC, STEEL/ALUMINUM "ICE WHITE"
2 GRUPPI AUTOMATICA, ACCIAIO/ALLUMINIO "ICE WHITE"



THE WAY TO BE





18 

IND3B

INDIE

3 GROUPS AUTOMATIC, STEEL/ALUMINUM "STEALTH BLACK"
3 GRUPPI AUTOMATICA, ACCIAIO/ALLUMINIO "STEALTH BLACK"

THE WAY TO BE







20 

IND3W

INDIE

3 GROUPS AUTOMATIC, STEEL/ALUMINUM "ICE WHITE"
3 GRUPPI AUTOMATICA, ACCIAIO/ALLUMINIO "ICE WHITE"



THE WAY TO BE



THE WAY TO BE PROFESSIONAL ESSERE PROFESSIONALI

COFFEE LAFTE

- 1 PRERISCALDAMENTO CONTINUO A 70° DELL'ACQUA DI INFUSIONE
- 2 RISCALDAMENTO FINALE ALLA TEMPERATURA DI INFUSIONE DIRETTAMENTE SUL GRUPPO EROGATORE
- 3 GRUPPO EROGATORE ISOLATO TERMICAMENTE PER OTTENERE MASSIMA SENSIBILITÀ ALLA REGOLAZIONE TERMICA E MINIMO DISPENDIO DI ENERGIA ELETTRICA
- 4 ACQUA DI INFUSIONE NON A CONTATTO CON RESISTENZE ELETTRICHE IN MODO DA GARANTIRE LA SUA MASSIMA OSSIGENAZIONE
- 5 GESTIONE INDIPENDENTE DI CIASCUN GRUPPO EROGATORE

- 1 CONTINUOUS WARMING TILL 70 C° OF THE WATER OF INFUSION
- 2 FINAL HEATING AT INFUSION TEMPERATURE DIRECTLY ON THE BREWING GROUP
- 3 THERMICALLY INSULATED BREWING GROUP FOR GETTING THE MAXIMUM SENSITIVITY OF THE THERMAL ADJUSTMENT AND MINIMUM ELECTRIC ENERGY CONSUMPTION
- 4 THE WATER OF INFUSION IS NOT IN CONTACT WITH THE ELECTRIC RESISTANCE IN ORDER TO ENSURE ITS MAXIMUM OXYGENATION
- 5 INDEPENDENT MANAGEMENT OF EACH BREWING GROUP

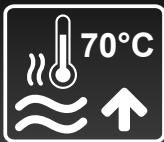

CONTINUOUS WARMING TILL 70°C

1

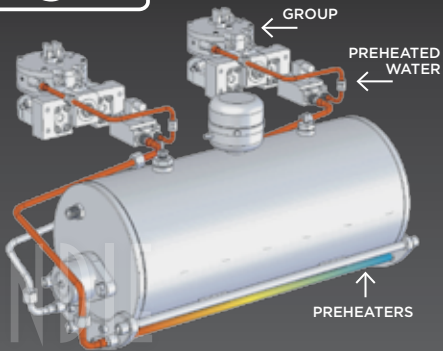

2

HOT WATER SUITABLE FOR INFUSION

HEATED WATER

DELIVERY

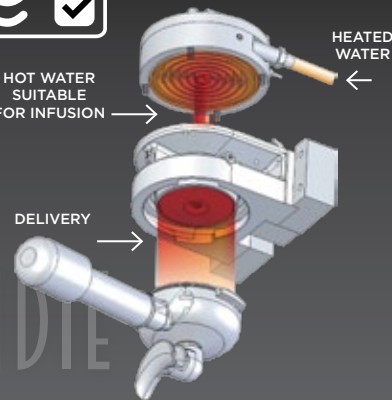

THERMALLY INSULATED BREWING GROUP

3

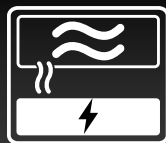
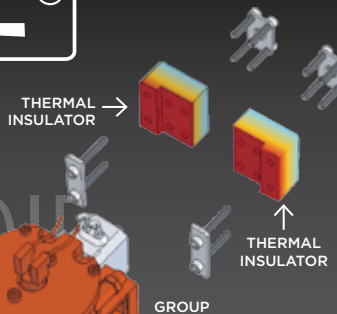

WATER INFUSION NOT IN CONTACT WITH ELECTRICAL RESISTANCE

4

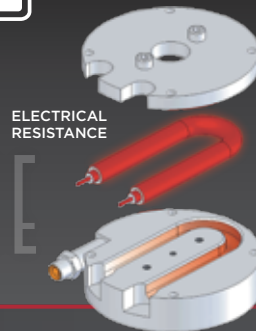

INDEPENDENT MANAGEMENT OF EACH BREWING GROUP

5



THE WAY TO BE BETTER ESSERE MIGLIORI

COFFEE CAFFÈ

- 1 CON LA MODALITÀ “COMPETITION”, ACCESSIBILE SELEZIONANDO L’ICONA SUL TOUCH SCREEN, IL BARISTA PIÙ ESPERTO POTRÀ AVERE INOLTRE IL CONTROLLO IN TEMPO REALE DI OGNI SINGOLO PARAMETRO DI ESTRAZIONE DEL GRUPPO.
- 2 PER RICORDARE AI BARISTI L’IMPORTANZA DELLA PULIZIA DELLE DOCCETTE GRUPPI, INDIE HA DEDICATO UNA SPECIFICA ICONA PER IL RISCIAQUO DELLE DOCCETTE, CHE SI FERMA AUTOMATICAMENTE DOPO 2 SECONDI DALL’ATTIVAZIONE.
- 3 IL SEGRETO DI UN BUON ESPRESSO STÀ NELLA MACINATURA DEL CAFFÈ. PER QUESTO ELEKTRA HA CREATO “NINO MK”, IL MACINADORATORE AUTOMATICO ON-DEMAND AD ELEVATE PRESTAZIONI, DOTATO DI UN SISTEMA DI PRESSATURA BREVETTATO.

- 1 WITH THE “COMPETITION” MODE, ACCESSIBLE BY SELECTING THE ICON ON THE TOUCH SCREEN, THE MOST EXPERT BARISTA WILL ALSO HAVE THE REAL-TIME CONTROL OF EVERY SINGLE GROUP EXTRACTION PARAMETERS.
- 2 TO REMIND BARISTAS ABOUT THE IMPORTANCE OF CLEANING THE GROUPS SHOWERS INDIE HAS DEDICATED A SPECIFIC ICON FOR THE RINSING OF THE SHOWERS WHICH STOPS AUTOMATICALLY AFTER 2 SECONDS OF PURGE.
- 3 THE SECRET OF A GOOD ESPRESSO IS IN THE COFFEE GRINDING. FOR THIS ELEKTRA HAS CREATED THE ON-DEMAND AUTOMATIC GRINDER “NINO MK”, WITH HIGH PERFORMANCE, EQUIPPED WITH A PATENTED PRESSING SYSTEM.

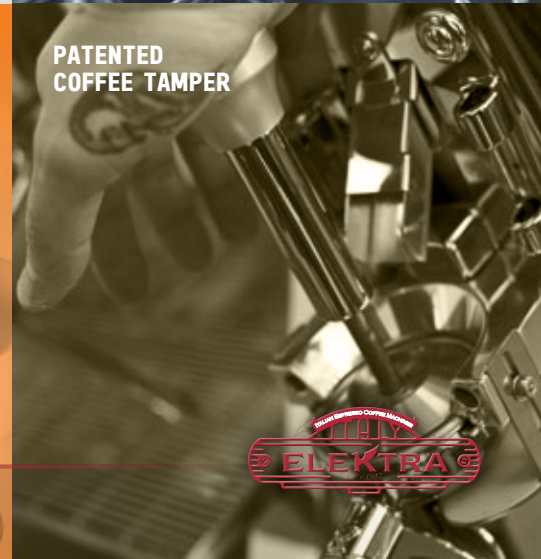
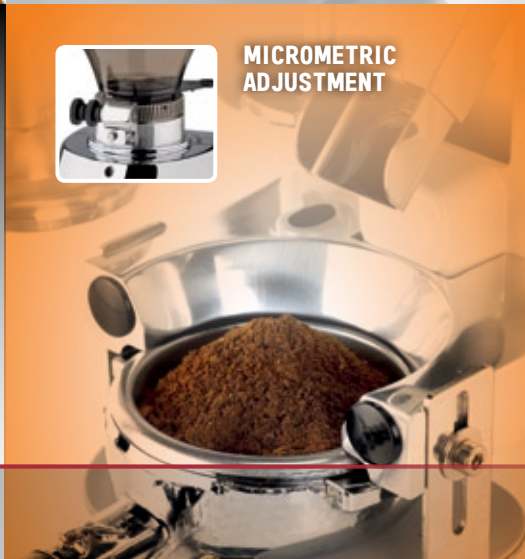

THE WAY TO GET HIGH PERFORMANCE

ELEVATE PRESTAZIONI

STEAM

VAPORE

- 1 CALDAIA DI GRANDE CAPACITÀ ESCLUSIVAMENTE DEDICATA ALLA PRODUZIONE DI VAPORE, DOTATA DI ISOLAMENTO TERMICO
- 2 PRODUZIONE DI VAPORE AD ALTA TEMPERATURA CON BASSO TASSO DI UMIDITÀ, PER MASSIMIZZARE LA PRODUZIONE E LA QUALITÀ DEL LATTE MONTATO
- 3 REGOLAZIONE DELLA PRESSIONE DI USCITA DEL VAPORE DIRETTAMENTE SULL'EROGATORE, PER OTTIMIZZARE LA MONTATURA IN BASE ALLA QUANTITÀ DI LATTE
- 4 CANNA VAPORE ERGONOMICA ANTISCOTTATURA

- 1 LARGE CAPACITY OF THE BOILER DEDICATED TO THE PRODUCTION OF STEAM ONLY, EQUIPPED WITH THERMAL INSULATION
- 2 HIGH TEMPERATURE STEAM PRODUCTION WITH LOW HUMIDITY RATE, TO MAXIMIZE PRODUCTION AND QUALITY OF FROTHED MILK
- 3 ADJUSTMENT OF THE STEAM OUTPUT PRESSURE DIRECTLY ON THE STEAM WAND, TO OPTIMIZE THE FROTHING OPERATION BASED ON THE QUANTITY OF MILK
- 4 ERGONOMIC COLD TOUCH STEAM WAND



1
LARGE CAPACITY
BOILER DEDICATE
TO THE STEAM ONLY

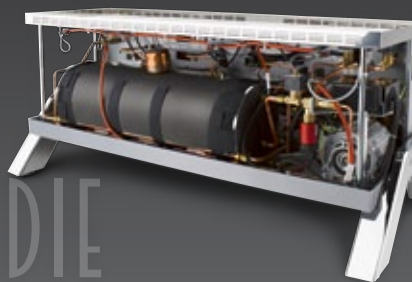

INDIE



2
HIGH
TEMPERATURE
STEAM PRODUCTION



3
ADJUSTMENT
OF THE STEAM
OUTPUT PRESSURE



4
ERGONOMIC
COLD TOUCH
STEAM WAND



28 THE WAY TO BE UNIQUE ESSERE UNICI

INDIE



Essere unici è la filosofia alla base del progetto INDIE. Unico come il suo elegante design non convenzionale o la raffinata finitura dei metalli e del legno. Unica come la sua avanzata tecnologia frutto di numerosi ed esclusivi brevetti, gestibile tramite intuitivi comandi touch-screen, per performance di livello assoluto.

Being unique is the philosophy behind the INDIE project. Unique as its elegant unconventional design or the refined finish of metals and wood. Unique as its advanced technology, the result of numerous patents, manageable through intuitive touch-screen commands, for absolute performance.

View more with QR code

INDIE TOP PLUS

INDIE TOP PLUS



STEAM POWER

At its best, thanks to its large capacity, and being dedicated to steam only, thermally insulated



VERY PURE HOT WATER

Water of infusion is not in contact with electrical resistance, in order to ensure its maximum oxygenation



TOUCH SCREEN DISPLAY

With intuitive icon interface. The first in the world used in an espresso machine with scrolling screens



HEATED CUPS HOLDER

With innovative heating technology. No need to remove it for maintenance



STEAM PRESSURE

Easy adjustment of the steam output pressure from 0.8 to 1.8 bar



HIGH TEMPERATURE STEAM PRODUCTION

With low humidity rate



STEAM WAND

Ergonomic cold-touch steam wand (avoid burns)



EXCLUSIVE HEATING OF INFUSION WATER

Final heating at infusion temperature set, directly on the brewing group



INNOVATIVE HEATING OF THE HYDRAULIC CIRCUIT

Constant warming till 70°C of the infusion water



ERGONOMIC HANDLE

Exclusive solid oak wood handle, designed just for INDIE

INDEPENDENT MANAGEMENT OF EACH BREWING GROUP

With coffee brewing parameters adjustable separately on each group



MFS

Programmable automatic milk frother. EXCLUSIVE PATENT



TRENDY LIGHTING

Multicolor led light on the back



ORIGINAL ITALIAN DESIGN

Charming unconventional style with easily removable metal body



PROFESSIONAL LIGHTING

Front lighting of the working area

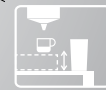

DRIP TRAY

Double height, for regular cups and take-away cups



ITALIAN COFFEE MACHINES SINCE 1947

espresso

MODELS / MODELLI

IND2B	INDIE	2 Units	Automatic	Steel/Aluminum "Stealth Black"
IND2W	INDIE	2 Units	Automatic	Steel/Aluminum "Ice White"
IND3B	INDIE	3 Units	Automatic	Steel/Aluminum "Stealth Black"
IND3W	INDIE	3 Units	Automatic	Steel/Aluminum "Ice White"

TECHNICAL DATA / DATI TECNICI

Units	Steam Boiler Capacity	Voltage	Frequency	Steam Boiler Power	Delivery Unit Power	Service Control Power	Weight	Shipping Weight
Gruppi	Capacità caldaia Vapore	Tensione	Frequenza	Potenza Caldaia	Potenza Gruppo	Servizi	Peso	Peso spedizione
N°	L	V	Hz	W	W	W	kg-lbs	kg-lbs
2	12	230-400	50/60	3500	800+800	200	71/157	93/205
3	16	230-400	50/60	5500	800+800+800	900	86/190	108/238



DIMENSIONS

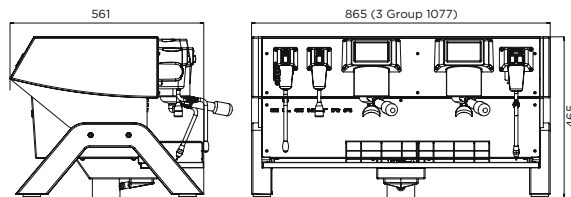

INSTALLATION SETUP

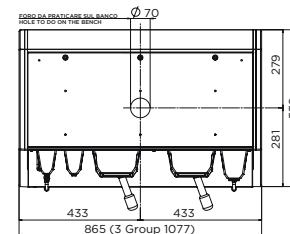





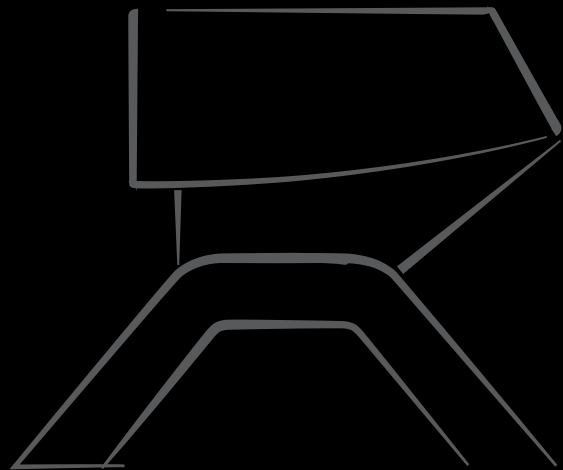



ITALIAN ESPRESSO MACHINES SINCE 1947

Elektra srl - Via A. Volta, 18
31030 Dossan di Casier (Treviso) Italy
Tel. +39.0422.490405 r.a. - Fax +39.0422.490620
www.elektrasrl.com - info@elektrasrl.com



INDIE
The Way to Be

